

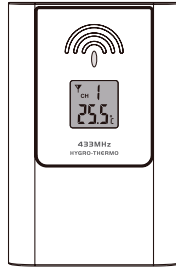

Digital Weatherstation | 719028

USER MANUAL

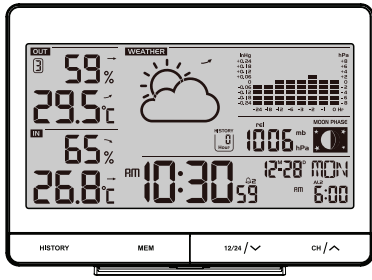

OVERVIEW

LCD MONITOR

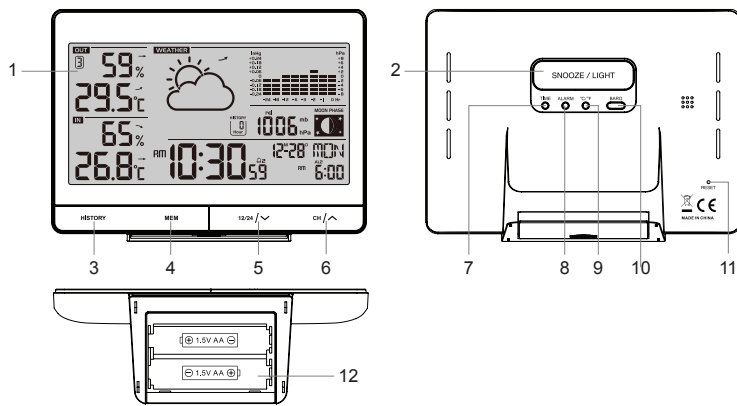

- LCD monitor
- [SNOOZE / LIGHT]** key
 - When alarm is sounding, press to stop the current alarm and enter snooze.
 - When alarm is sounding, press and hold for 2 seconds to stop the current alarm, the clock will sound again in the next day.
- [HISTORY]** key
 - In normal mode, press to display the past 24 hour pressure records.
- [MEM]** key
 - In normal mode, press to check maximum and minimum thermo-hygro reading, or press and hold for 3 seconds to delete both records.
- [12/24 / V]** key
 - In normal mode, press to switch between 12 or 24 hour format of time display, or press and hold for 3 seconds to activate wireless sensor pairing mode.
 - In setting mode, press to decrease the setting values.
- [CH / A]** key
 - In normal mode, press to switch between CH 1~3 of outdoor sensor's weather display, or press and hold for 2 seconds to enter auto-cycle mode.
 - In setting mode, press to increase the setting values.
- [TIME]** key
 - In normal mode, press to switch between alarm 1 and alarm 2, or press and hold for 2 seconds to enter time setting mode.
 - In time setting mode, press to step the setting.
- [ALARM]** key
 - In normal mode, press to turn on/off alarm1 and alarm 2, or press and hold for 2 seconds to enter alarm setting mode.
 - In alarm setting mode, press to step the setting.
- [°C / °F]** key
 - In normal mode, press to switch between Celsius and Fahrenheit.
- [BARO]** key
 - In normal mode, press to switch between hPa (mb) and inHg, or press and hold for 3 seconds to enter the "rel" and "abs" switch mode.
- [RESET]** key
 - In case of malfunction, press to reset the main unit.
- Battery compartment

LCD MONITOR

- Ch. 1-3 temperature & humidity reading
- Indoor temperature & humidity reading
- Weather forecast, Baro pressure & moon phase section
- Time and calendar section

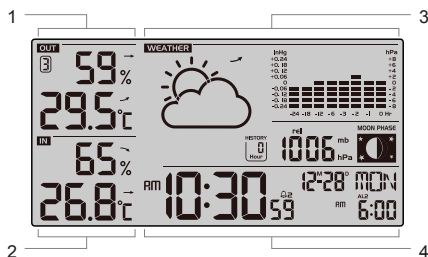

WIRELESS SENSOR

- LED indicator
 - Flashes when the remote unit is transmitting.
- LCD display
 - to show the detected temperature or humidity of the sensor.
- Wall mounting holder
- [RESET]** key
 - Press to restart the sensor.
- [CHANNEL]** slide switch
 - Assign the transmitter to Channel from 1 to 3.
- Battery compartment
 - Accommodates 2 x AA size batteries.

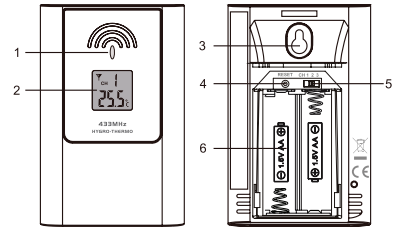

GETTING STARTED

WIRELESS SENSOR

- Remove the battery door.
- Insert 2 x AA size batteries into the battery compartment. Make sure you insert them the right way according to the polarity information marked on the battery compartment.
- Replace the battery door.

The sensor will now start transmitting signals, and LED indicator flashes.

NOTE:

- Once the channel is assigned to a sensor, you can only change it by removing the batteries or resetting the sensor, you also need to press and hold **[12/24 / V]** key for 3 seconds on main unit to pair this sensor.
- After replacing the batteries of the wireless sensor or the unit fails to receive wireless sensor signal of a specified channel, you need to press and hold **[12/24 / V]** key for 3 seconds on main unit to pair this sensor again.
- Avoid placing the transmitter in direct sunlight, rain or snow.
- The building material and the position of the receiver and transmitter affect the effective range. So try various locations to obtain the best result.
- Place the units away from metal objects and electrical appliances to minimize the interference. Position the receiver and transmitter within the effective transmission range: 30m in usual circumstances.

LCD MONITOR

- Remove the battery door and insert 2 x AA batteries into the battery compartment, according to the polarity mark on the battery compartment.
- After the batteries are installed, all LCD segment will be shown.
- Press the **[RESET]** key of main unit first.
- Replace the battery door.

NOTE:

If no display appears on the LCD after installing the batteries, press the **[RESET]** key by using a metal wire.

VIEW MULTIPLE WIRELESS SENSOR CHANNELS

- In normal mode, press **[CH / A]** key to switch the display between CH 1~3.
- In normal mode, press and hold **[CH / A]** key for 2 seconds to enter auto-cycle mode. After a "bi" sounds, it will alternately displays the CH 1~3 at 4 second intervals.
- During auto-cycle mode, press **[CH / A]** key again to stop auto-cycle mode and display the current channel.

TIME AND CALENDAR SETTING

- In normal mode, press and hold **[TIME]** key for 2 seconds to enter date and time setting mode.
- Press **[CH / A]** or **[12/24 / V]** key to adjust the setting.
- Press **[TIME]** key to enter the next setting.
- The setting sequence: year → DM / MD → month → day → hour → minute → second → weekday language.
- Press **[TIME]** key or leave the unit for 30 seconds to complete the setting and return to normal mode.
- Weekday language GB → FR → DE → ES → IT

ALARM TIME SETTING AND DISPLAY

- In normal time mode, press **[TIME]** key to select the alarm 1 or alarm 2.
- In alarm1/alarm2 mode, press and hold **[ALARM]** key for 2 seconds until alarm hour digit flashes.
- Press **[CH / A]** or **[12/24 / V]** key to change the value
- Repeat the above operations to set the alarm time in this order: Hour → Minute → Ice pre-alarm on/off.
- Press **[ALARM]** key or leave the unit for 30 seconds to return to normal mode.



USING ALARM AND SNOOZE FUNCTION

- Set the desired alarm time as described in the previous section.
- Or press **[ALARM]** key to turn on alarm 1, press it again to turn on alarm 2, press it thrice to turn on both alarm 1 and alarm 2, with the alarm icons "A1" and / or "A2" displays on the LCD. Press it again to turn off both alarm 1 and alarm 2, with the icons disappear.
- When clock reach the alarm time, alarm sound will start.

Where it can be stopped by following operation:

- Auto-stop after 2 minutes alarming if without any operation and the alarm will activate again in the next day.
- By pressing **[SNOOZE / LIGHT]** key to enter snooze that the alarm will sound again after 5 minutes.
- By pressing and hold **[SNOOZE / LIGHT]** key for 2 seconds to stop the alarm and will activate again in the next day
- By pressing **[ALARM]** key to stop the alarm and the alarm will activate again in the next day.

NOTE:

- The alarm function will turn on automatically once you set the alarm time.
- The snooze could be used continuously in 24 hours.
- During the snooze, the alarm icons "A1" and / or "A2" will keep flashing.

- The ice pre-alarm will be activated when the alarm 1 and / or 2 is on.
- Once the ice pre-alarm activates, the preset alarm will sound 30 minutes earlier if the outdoor temperature is below -3°C.
- To activate the ice pre-alarm function, pls ensure:
 - a. Turn on the ice pre-alarm function in the alarm setting mode.
 - b. Turn on the corresponding alarm.

READING INDOOR/OUTDOOR TEMPERATURE & HUMIDITY FUNCTION

In normal mode, press [°C / °F] key to switch between °C / °F temperature unit. The temperature and humidity will display "Hi / Lo / --" on the conditions in the following chart:



Area	Condition	Display
Temperature	Temperature < -40°C	LO
	Temperature > 70°C	HI
Humidity	Humidity < 20%	LO
	Humidity > 90%	HI
	Temperature < -40°C or > 70°C	--

NOTE:

- If no signals are received or the transmission is interfered, "--" will appear on the LCD.
- Relocated the clock or transmitter in other positions and make sure the transmission is within the effective range of 30m approx.

BARO, TEMPERATURE AND HUMIDITY TREND

The Barometric pressure, temperature and humidity trend indicator shows the trends of changes in the forthcoming few minutes. Arrows indicate a rising, steady or falling trend.

Arrow indicator			
Trend	Rising	Steady	Falling

BAROMETRIC/ATMOSPHERIC PRESSURE

TO SELECT THE PRESSURE DISPLAY MODE

Press and hold the [BARO] key for 2 seconds to enter select model that allow you select between:

- abs --- the absolute atmospheric pressure of your location.
- rel --- the relative atmospheric pressure based on the sea.

TO SET RELATIVE ATMOSPHERIC PRESSURE VALUE

1. Get the atmosphere pressure data of the sea level (it is also the relative atmosphere pressure data of your home area) through the local weather service, internet and other weather channels.
2. Press and hold [BARO] key for 2 seconds until "abs" or "rel" icon flashes.
3. Press [CH / Λ] or [12/24 / V] key to switch to "rel" mode.
4. Press [BARO] key once again until the "rel" atmosphere pressure digit flashes.
5. Press [CH / Λ] or [12/24 / V] key to change its value.
6. Press [BARO] key to save and exit the setting mode, or let it exit automatically 30 seconds later without pressing any key.

TO SELECT THE MEASUREMENT UNIT FOR THE BAROMETER







Use the [BARO] key to change the unit between hPa (mb) / inHg.

NOTE:

- When power up the main unit, it will display the relative pressure reading and default value is 1013 mb/hPa (29.91 inHg), which refers to the average atmosphere pressure.
- When you change the relative atmosphere pressure value, the weather indicators will change along with it.
- The relative atmosphere pressure is based on the sea level, but it will change with the absolute atmosphere pressure changes after operating the clock for 1 hour.

WEATHER FORECAST

The built-in barometer can notice atmosphere pressure changes. Based on the data collected, it can predict the weather conditions in the forthcoming 24 ~ 72 hours.

					
Sunny	Partly Cloudy	Cloudy	Rainy	Stormy	Snowy

NOTE:

1. The accuracy of a general pressure-based weather forecast is about 70% to 75%.
2. The weather forecast is meant for the next 24 ~ 72 hours, it may not necessarily reflect the current situation.
3. The **Snowy** weather forecast is not based on the atmospheric pressure, but based on the temperature of current channel. When the outdoor temperature is below -3°C, the **Snowy** weather indicator will be displayed on the 24 HOUR FORECAST display section.

PAST 24 HOURS HISTORY PRESSURE RECORD

The current and historical atmosphere is shown near the 24 HOUR FORECAST section.

To check the pressure history in a particular hour during the past 24 hours, press the [HISTORY] key. Each press on the key will go back by an hour.

Under the pressure history mode, press any key (except [HISTORY] key) to go back the normal mode, or let it exit automatically 30 seconds later without pressing any key.



HISTORY GRAPH

The history graph is under the time section of the LCD displays that can show the Baro histories in bar chart format.

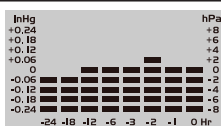









MAX / MIN RECORD

The main unit preserves the MAX / MIN weather data records since the last manual reset.



1. In normal mode, press [MEM] key once to show the indoor & current outdoor channel maximum temperature and humidity records.
2. Press [MEM] key repeatedly to show the minimum records.
3. Press [MEM] key again to exit.
4. To erase all the MAX / MIN records, press and hold [MEM] key for 3 seconds.

MOON PHASE

The main unit can show the Southern hemisphere moon phase status, below is the table which illustrate how the moon will appear on the main unit.

Moon Phase Icon	Description	Moon Phase Icon	Description
	New Moon		Full Moon
	Waxing Crescent		Waning Gibbous
	First quarter		Third quarter
	Waxing Gibbous		Waning Crescent

LOW BATTERY ICON

When the battery indicator " " appear on the clock section or the LCD becomes dim, replace with 2 new AA size batteries at once; while If the low battery indicator " " appear in the outdoor section, it indicates that the battery power of the transmitter is not enough, and you should replace with 2 x AA size batteries at once.

IMPORTANT NOTE

- This main unit is intended to be used only indoors.
- Do not subject the unit to excessive force, shock, dust, temperature or humidity.
- Do not cover the ventilation holes with any items such as newspapers, curtains etc.
- Do not immerse the unit in water. If you spill liquid over it, dry it immediately with a soft, lint-free cloth.
- Do not clean the unit with abrasive or corrosive materials.
- Do not tamper with the unit's internal components. This invalidates the warranty.
- Only use fresh batteries. Do not mix new and old batteries.
- Do not dispose old batteries as unsorted municipal waste. Collection of such waste separately for special treatment is necessary.
- Attention! Please dispose of used unit or batteries in an ecologically safe manner.
- Technical specifications and user manual contents for this product are subject to change without notice.

SPECIFICATIONS

MAIN UNIT

Dimensions (W x H x D)	140 x 103.5 x 51mm
Main power	2 x AA size 1.5V batteries
Barometer display range	540 to 1100hPa, 15.95 to 32.49inHg
Operating temperature range	-5°C to 50°C (23°F to 122°F)
Display temperature range (In / Outdoor)	-40°C to 70°C (-40°F to 158°F)
Display humidity range (In / Outdoor)	RH 20% to 90 %
Resolution of temperature	1 decimal place of °C/°F (above -10°C / °F) Integer of °C/°F (below -10°C / °F or above 100 °F)
Resolution of humidity	1%
Number of sensors support	Up to 3 units

WIRELESS SENSOR

Dimensions (W x H x D)	65 x 100 x 35mm
Main power	2 x AA size 1.5V batteries (Lithium battery recommended for low temperature environment)
Operating temperature range	-20°C to 60°C (-4°F to 140°F)
Operating humidity range	RH 1% to 99 % (non-condensing)
RF frequency	433MHz
RF transmission range	30 meters

Ames Australasia warrants that this product will be free from defects in workmanship and materials for 2 years. If a defect in material or workmanship becomes evident during that period, Ames Australasia will, at its option, either; repair the product (or pay for the costs of repair of the product); replace the product; or refund to the customer the purchase price paid by the customer for the product. In the event of such a defect, the product should be returned to the place of purchase, together with proof of purchase for repair, replacement or refund. Any handling and transportation (and other expenses incurred in claiming under this guarantee) are not covered by this guarantee and will not be borne by Ames Australasia. The obligation of Ames Australasia under this guarantee is limited to the circumstances set out about and is subject to; the customer being able to evidence the acquisition of the product, the purchase price paid for the product and the relevant defect in materials or workmanship; the product not having been altered, tampered with or otherwise dealt with by any person in a manner other than as intended in respect of the relevant product; and the product not having been used or applied in a manner that is contrary to customary usage or application for the relevant product or contrary to any stated instructions or specification of Ames Australasia. Our goods come with guarantees that cannot be excluded under the Australian Consumer Law. You are entitled to a replacement or refund for a major failure and for compensation for any other reasonably foreseeable loss or damage. You are also entitled to have the goods repaired or replaced if the goods fail to be of acceptable quality and the failure does not amount to a major failure. The benefits given by this guarantee are in addition to the other rights and remedies which might be available to the customer under any law in relation to goods or services to which this guarantee relates.

For further information contact us on
Australia Free Call: 1800 335 019 New Zealand: 09 427 6042

AMES Australasia
ABN 89 169 427 061
Level 1, 660 Doncaster Road, Doncaster,
Victoria 3108, Australia

www.nylex.com.au

